



HANGCHA GROUP CO., LTD.

Factory site: 666 Xiangfu Road,
Hangzhou, Zhejiang, China (311305)

Tel: +86-571-88926735 88926755
Fax: +86-571-88926789 88132890

sales@hcforklift.com www.hcforklift.com



Follow us on
Facebook



Follow us on
YouTube



Follow us on
WeChat



Download "Hangcha
Forklift" App



ISO45001:2018



ISO14001:2015



ISO9001:2015



HANGCHA trucks conform
to the European Safety
Requirements.

X SERIES

HI-RANGE ELECTRIC STACKER
WITH LITHIUM POWER

With capacity of 1,200 to 2,000kg

HANGCHA GROUP CO., LTD. reserves the right to make any changes without notice concerning colors, equipment, or specifications detailed in this brochure, or to discontinue individual models. The colors of trucks, delivered may differ slightly from those in brochures.

LET THE LIUM POWER BE FREED



HANGCHA provides Li-ion battery (LiFePO4) with 6 years or 12000 hours warranty.

**6 YEARS
WARRANTY**

INNOVATIVE SOLUTIONS NEW POWER NOW

Innovative, reliable lithium-ion technology (Lithium Iron-Phosphate), which are developed jointly by HANGCHA and EVE. Battery cells and modules are from EVE, with reliable quality, exclusively for HANGCHA.

- / We use square lithium iron phosphate batteries and modules used in large quantities by commercial vehicles in mature economies.
- / Safe and effective: Charging efficiency as high as 95%.
- / Quick charging.
- / Long-working: 2000 charging cycles, capacity retention greater than 80%.
- / Maintenance-free: Battery does not require manual maintenance.
- / Green and clean: Pollution-free, zero emissions.

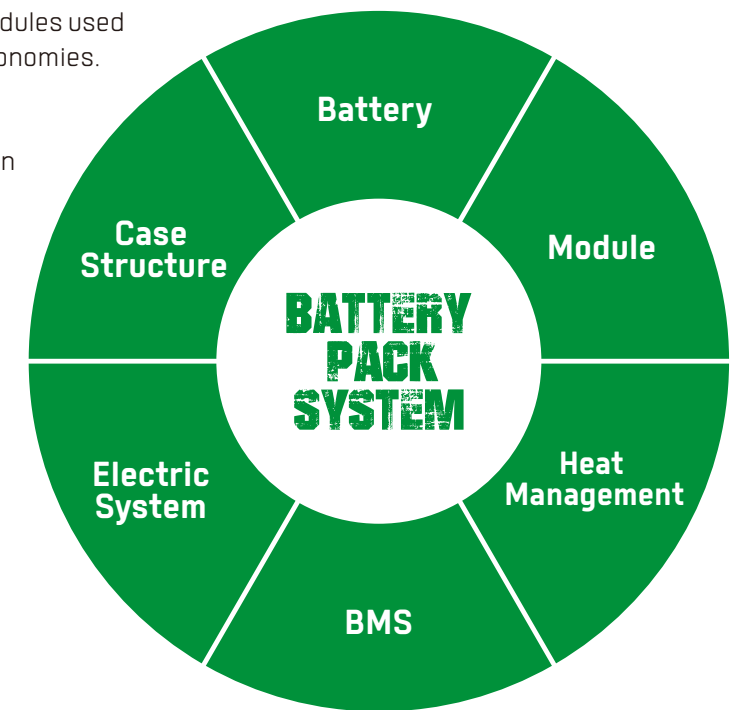

Rapid charging and opportunity charging ensure continuous availability of vehicles

Allow for fast full charging or boost charging. They are maintenance free and do not require a battery change when used for multi-shift operations.

POWERFUL DESIGN TO INCREASE PRODUCTIVITY

RELIABLE OPERATIONS ■

MAINTENANCE COSTS ■

RELIABILITY ■

■ NEW 48V SYSTEM

■ PERFORMANCE

■ COMFORTABLE

■ SAFE



X SERIES HI-RANGE ELECTRIC STACKER

Your reliable, powerful and connected working machine.

X series Hi-Range Electric stackers are a new generation of products newly developed by Hangcha for warehousing and logistics applications. Using the advanced permanent magnet brushless drive technology and equipped with a new 48V system, the products have advanced performance, comfortable, safe and reliable operations and low use and maintenance costs, and are ideal tools for loading, unloading and handling palletized goods in warehouses, supermarkets, workshops and homes.

RUGGED ON THE OUTSIDE.

Made of high-strength steel plates that are molded by stamping, the vehicle exterior is robust, durable and high-grade, and meets environmental protection requirements.

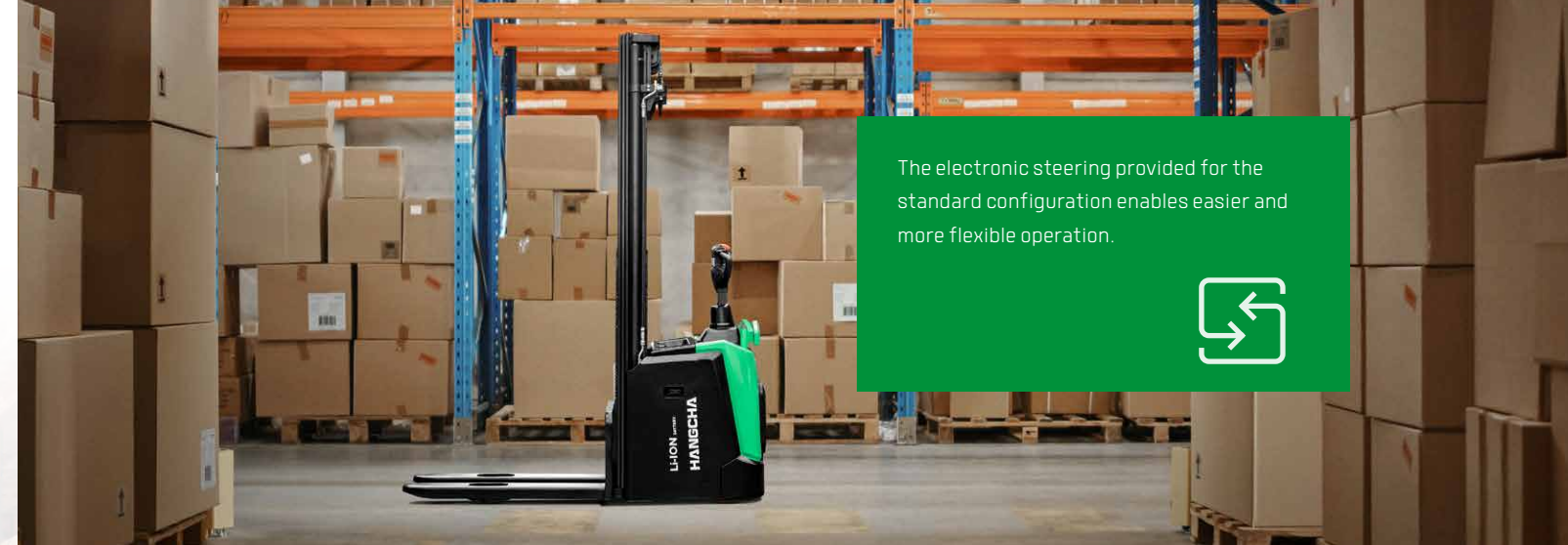

The electronic steering provided for the standard configuration enables easier and more flexible operation.





HIGH PERFORMANCE

- With high power drive motor, provides fast travel speed and good gradeability.
- The permanent magnet synchronous drive system has excellent performance and low energy consumption. The 48V power supply system has less heat generated.
- With the VCU control, the vehicle can be controlled accurately, stably and more efficiently.

48V
V O L T A G E
WITH
PERMANENT MAGNET
SYNCHRONOUS DRIVE MOTOR

Pedestrian type

 **6.0 Km/h**
Travel speed (laden)

 **8.0 %**
Gradeability (laden)(1.6t)

Stand-on type

 **9.0 Km/h**
Travel speed (laden)

 **10 %**
Gradeability (laden)(1.6t)

APPEARANCE

The X series Hi-Range Electric stackers adopts a professional industrial design of exterior and a series family design. The vehicle has a smooth vivid profile and a fully ergonomic design, following the latest exterior design trend.



SIMPLE OPERATION

The proportional descending speed regulation system provided for the standard configuration enables more stable and accurate operation.

System Stepless lifting and descending speed regulation is provided for the standard configuration, to and spillage more precise fork control and more stable goods lifting and descending.

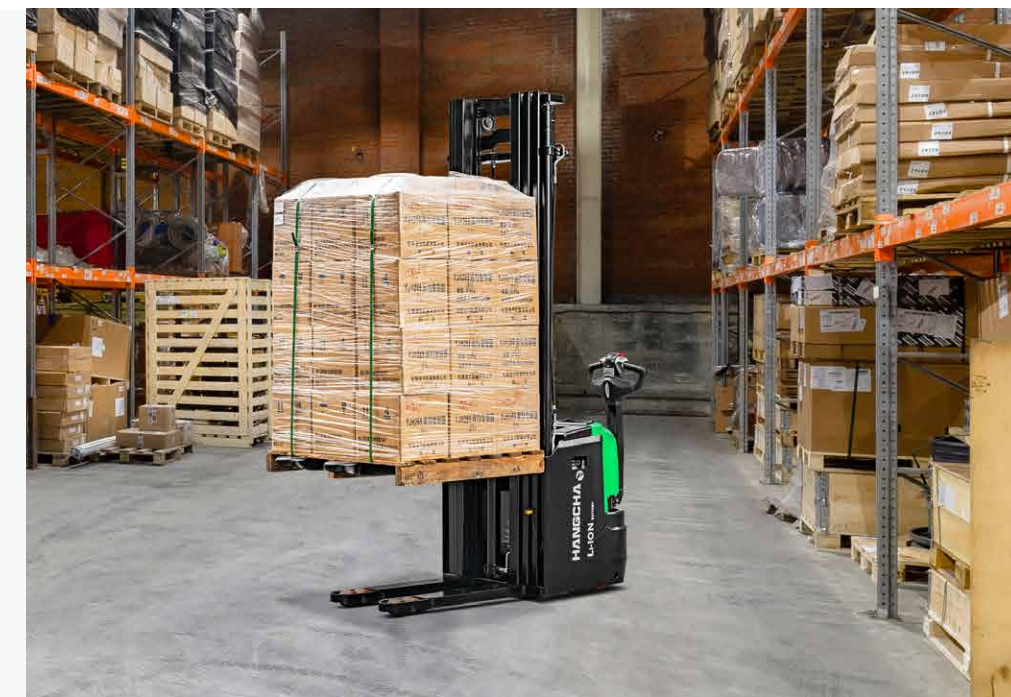

ENJOY YOUR WORK.

- Optimized designing structure to offer a good visibility and easy entrance of the pallet.
- The compact body and big rounded design provide an ideal operation in limited space, and the wedge designed chassis greatly increases the passing ability.



The standing driving pedal with shock-absorbing design significantly improves standing driving comfort and reduces long-time driving fatigue.



Customer can choose different width of outside fork and length of forks to fit variable pallet.

NEW TILLER

With the novelly developed compact and stylish tiller, all operations can be completed with one hand.



PIN code access

Displayed turtle speed function applied to move slowly and helps to stack goods in narrow spaces.



MAINTENANCE

- Maintenance-free permanent magnet synchronous motor.
- The fault information can be checked directly via the interactive instruments instead of the manual.
- Rear cover can be completely open, operator can see all the components, so the maintenance is very convenient.
- All shafts installed lubricated shaft sleeve and oil cup, provide convenient maintenance and long service life.



MORE PROTECT

- With the four-point low center of gravity design and a high-strength steel frame structure, the vehicle frame has a large residual load capacity and a long service life.
- Using non-contact proximity switch, it can provides long life and reliable operation.
- H-type mast profile section to provide more stable and rigid performance.
- The battery is reliably fixed and the battery cover is Support by soft materials, so that the vibration and noise generated during the operation of the vehicle are reduced.



Pedestrian type use the new design drive system, the drive motor will not accompany the tiller rotation, it can keep all the cable connect to the drive motor avoid being bent.



With a low noise and low vibration hydraulic power unit to enable stable and reliable lifting and descending.



The power plug is fixed on the truck body to avoid damage from battery installment.

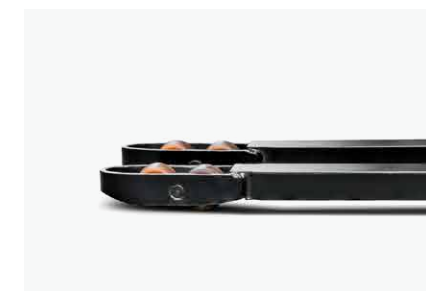

Punch-formed forks to provide more strength and tip guide to provide higher efficient operation.



Water-proof plugs and connectors applied to provide a reliable protection to electric system.

With three braking types:

Releasing brake, reversing brake and emergency brake, the driving safety has been ensured.



The applied slope anti-slip function ensures the safety of the operation.

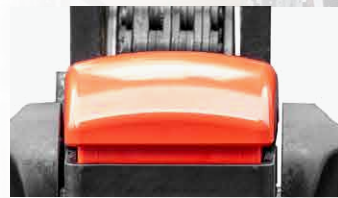

The emergency button on the tiller head can effectively avoid the harm to the driver.



ADVANCED SAFETY FEATURES

1

After fork lifting 500mm.

2

Decrease speed when turning

3

Soft Landing (Lift)

4

Soft Landing (Lowering)

5

1800mm

1 Travel speed will be automatically reduced after fork lifting 500mm.

2 Turning speed is automatically reduced when steering only for stand-on.

3 A lifting soft landing is provided for the standard configuration so as to ensure the safety of the vehicle when the fork is lifted to the top.

4 It has an intelligent soft landing that automatically slows down the lowering speed when the fork is less than 100mm above the ground, effectively protecting cargo safety.

5 For the standard configuration, a function of stopping lifting when the lifting height reaches the limit of 1.8m and resuming the lifting after the guardrails are retracted is provided to facilitate personnel to escape when high-position goods fall.

1.2t Mast Specification

Type	Max. lifting height h ₃	Ground clearance, fork (h ₃ +h ₁₃)	Lowered height h ₁	Extended height h ₄	Free lift	Load Capacity at 600mm	
						1.2t	
Double cylinder duplex wide view	mm	mm	mm	mm	mm	kg	
	2100	2190	1540	2590	90	1200	
	2500	2590	1740	2990	90	1200	
	2700	2790	1840	3190	90	1200	
	3000	3090	1990	3490	90	1200	
	3200	3290	2090	3690	90	1200	
Duplex full-free wide view	3400	3490	2190	3890	90	1170	
	3600	3690	2290	4090	90	1100	
	2100	2190	1540	2590	1070	1200	
	2500	2590	1740	2990	1270	1200	
	2700	2790	1840	3190	1370	1200	
	3000	3090	1990	3490	1520	1200	
Triplex full-free wide view	3200	3290	2090	3690	1620	1200	
	3400	3490	2190	3890	1720	1170	
	3600	3690	2290	4090	1820	1100	
	3600	3690	1660	4080	1195	1100	
	3900	3990	1760	4380	1295	990	
	4100	4190	1830	4580	1360	920	
	4300	4390	1890	4780	1425	850	
	4500	4590	1960	4980	1495	760	
4700	4790	2030	5180	1560	700		

1.4-1.6t Mast Specification

Type	Max. lifting height h ₃	Ground clearance, fork (h ₃ +h ₁₃)	Lowered height h ₁	Extended height h ₄	Free lift	Load Capacity at 600mm	
						1.4t	1.6t
Double cylinder duplex wide view	mm	mm	mm	mm	mm	kg	kg
	2000	2090	1540	2540	90	1400	1600
	2400	2490	1740	2940	90	1400	1600
	2700	2790	1890	3240	90	1400	1600
	2900	2990	1990	3440	90	1400	1600
	3000	3090	2040	3540	90	1400	1600
	3300	3390	2190	3840	90	1250	1350
	3500	3590	2290	4040	90	1150	1220
	3800	3890	2440	4340	90	1030	1080
	4000	4090	2540	4540	90	950	1000
	4200	4290	2640	4740	90	890	940
	4500	4590	2790	5040	90	760	810
	2000	2090	1540	2540	1020	1400	1600
	2400	2490	1740	2940	1220	1400	1600
Duplex full-free wide view	2700	2790	1890	3240	1370	1400	1600
	3000	3090	2040	3540	1520	1400	1600
	3300	3390	2190	3840	1670	1250	1350
	3500	3590	2290	4040	1770	1150	1220
	3500	3590	1660	4020	1160	1150	1220
	3800	3890	1760	4320	1260	1030	1080
	4000	4090	1830	4520	1330	950	1000
	4200	4290	1890	4720	1390	890	940
	4500	4590	2030	5020	1490	760	810
	4700	4790	2060	5220	1560	700	750
Triplex full-free wide view	4800	4890	2090	5320	1590	680	730
	5000	5090	2160	5520	1660	650	700
	5200	5290	2230	5720	1730	600	650
	5500	5590	2330	6020	1830	550	600
	6000	6090	2500	6520	2000	450	500

2.0t Mast Specification

Type	Max. lifting height h ₃	Ground clearance, fork (h ₃ +h ₁₃)	Lowered height h ₁	Extended height h ₄	Free lift	Load Capacity at 600mm	
						2.0t	
Double cylinder duplex wide view	mm	mm	mm	mm	mm	kg	
	2050	2140	1660	2690	90	2000	
	2250	2340	1760	2890	90	2000	
	2400	2490	1830	3030	90	2000	
	2700	2790	1990	3340	90	1800	
	3000	3090	2140	3640	90	1600	
	3200	3290	2240	3840	90	1470	
	3400	3490	2340	4040	90	1340	
	3600	3690	2440	4240	90	1200	
	3800	3890	2540	4440	90	1130	
	4000	4090	2640	4640	90	1050	
	4300	4390	2850	5000	90	950	
	4500	4590	2950	5200	90	860	
	2050	2140	1660	2690	1020	2000	
2250	2340	1760	2890	1120	2000		
Duplex full-free wide view	2400	2490	1830	3030	1200	2000	
	2700	2790	1990	3340	1350	1800	
	3000	3090	2140	3640	1500	1600	
	3200	3290	2240	3840	1300	1470	
	3400	3490	2340	4040	1700	1340	
	3600	3690	2440	4240	1800	1200	
	3500	3590	1800	4150	1165	1270	
	3800	3890	1900	4450	1260	1130	
	4000	4090	1965	4650	1300	1050	
	4200	4290	2030	4850	1395	990	
Triplex full-free wide view	4500	4590	2130	5150	1495	860	
	4800	4890	2230	5450	1595	780	
	5000	5090	2330	5650	1660	750	
	5500	5590	2465	6150	1830	650	
	6000	6090	2640	6650	2000	550	

Technical data

Distinguishing mark	1.1	Manufacturer	HANGCHA GROUP CO.,LTD.				
	1.2	Manufacturer's type designation	CDD12-XT1S-SI	CDD14-XT1S-SI	CDD16-XT1S-SI	CDD20-XT1S-SI	
1.5	Rated capacity	Q (kg)	1200	1400	1600	2000	
1.6	Load centre distance	c (mm)	600	600	600	600	
1.8	Load distance, centre of drive axle to fork	x (mm)	700	700	700	700	
1.9	Wheelbase	y (mm)	1296	1331	1331	1331	
Weight	2.1.1	Service weight	(kg)	1200	1220	1230	1260
Tyres, chassis	3.1	Tyres: solid rubber, superelastic, pneumatic, polyurethane	PU	PU	PU	PU	
	3.2	Tyre size, front	(mm)	Ø250-80	Ø250-80	Ø250-80	Ø250-80
	3.3	Tyre size, rear	(mm)	Ø83-80	Ø83-80	Ø83-80	Ø83-80
	3.4	Additional wheels (dimensions)	(mm)	Ø125-50	Ø125-50	Ø125-50	Ø125-50
	3.5	Wheels, number front/rear (* = driven wheels)	(mm)	1x +1/4	1x +1/4	1x +1/4	1x +1/4
	3.6	Tread, front	b10 (mm)	516	516	516	516
3.7	Tread, rear	b11 (mm)	385	385	385	385	
Dimensions	4.4	Lift	h3 (mm)	2700	2700	2700	2700
	4.15	Height, lowered	h13 (mm)	90	90	90	90
	4.19	Overall length	l1 (mm)	1987	2019	2019	2019
	4.20	Length to face of forks	l2 (mm)	834 ³⁾	869 ³⁾	869 ³⁾	869 ³⁾
	4.21	Overall width	b1/b2 (mm)	800	800	800	800
	4.22	Fork dimensions DIN ISO 2331	s/e/l (mm)	60/185/1150	60/185/1150	60/185/1150	65/185/1150
	4.25	Fork spread	b5 (mm)	570/680	570/680	570/680	570/680
	4.32	Ground clearance, centre of wheelbase	m2 (mm)	25	25	25	25
	4.34.1	Aisle width for pallets 1000 • 1200 crossways	Ast (mm)	2201[2632] ¹⁾	2236[2667] ¹⁾	2236[2667] ¹⁾	2236[2667] ¹⁾
	4.34.2	Aisle width for pallets 800 • 1200 lengthways	Ast (mm)	2251[2682] ²⁾	2286[2717] ²⁾	2286[2717] ²⁾	2286[2717] ²⁾
4.35	Turning radius	Wa (mm)	1551[1982]	1586[2017]	1586[2017]	1586[2017]	
Performance data	5.1	Travel speed, laden/unladen	(km/h)	9/11	9/11	9/11	8/10
	5.2	Lift speed, laden/unladen	(m/s)	0.225/0.47	0.195/0.4	0.18/0.4	0.16/0.34
	5.3	Lowering speed, lade/unladen	(m/s)	0.45/0.4	0.45/0.4	0.45/0.4	0.5/0.4
	5.8	Max. gradeability, laden/unladen	(%)	10/16	10/16	8/16	8/16
Electric-engine	6.1	Drive motor rating S2 60 min	(kW)	2.2	2.2	2.2	2.2
	6.2	Lift motor rating at S3 15 %	(kW)	4.2	4.2	4.2	4.2
	6.4	Battery voltage/nominal capacity	(V)/(Ah)	48/80	48/80	48/80	48/80
	6.4.1	Optional battery voltage/nominal capacity	(V)/(Ah)	48/105 48/125	48/105 48/125	48/105 48/125	48/105 48/125
	8.1	Type of drive unit		Permanent magnet synchronous			

Note: 1) According to VDI2198 standard+220mm. 2)According to VDI2198 standard+140mm. 3)Triplex full-free+21mm

Technical data

Distinguishing mark	1.1	Manufacturer	HANGCHA GROUP CO.,LTD.				
	1.2	Manufacturer's type designation	CDD12-XT1-SI	CDD14-XT1-SI	CDD16-XT1-SI	CDD20-XT1-SI	
1.5	Rated capacity	Q (kg)	1200	1400	1600	2000	
1.6	Load centre distance	c (mm)	600	600	600	600	
1.8	Load distance, centre of drive axle to fork	x (mm)	700	700	700	700	
1.9	Wheelbase	y (mm)	1318	1318	1318	1318	
Weight	2.1.1	Service weight	(kg)	1020	1040	1040	1080
Tyres, chassis	3.1	Tyres: solid rubber, superelastic, pneumatic, polyurethane	PU	PU	PU	PU	
	3.2	Tyre size, front	(mm)	Ø250-80	Ø250-80	Ø250-80	Ø250-80
	3.3	Tyre size, rear	(mm)	Ø83-80	Ø83-80	Ø83-80	Ø83-80
	3.4	Additional wheels (dimensions)	(mm)	Ø125-50	Ø125-50	Ø125-50	Ø125-50
	3.5	Wheels, number front/rear (* = driven wheels)	(mm)	1x +1/4	1x +1/4	1x +1/4	1x +1/4
	3.6	Tread, front	b10 (mm)	510	510	510	510
3.7	Tread, rear	b11 (mm)	385	385	385	385	
Dimensions	4.4	Lift	h3 (mm)	2700	2700	2700	2700
	4.15	Height, lowered	h13 (mm)	90	90	90	90
	4.19	Overall length	l1 (mm)	1934	1934	1934	1934
	4.20	Length to face of forks	l2 (mm)	784 ³⁾	784 ³⁾	784 ³⁾	784 ³⁾
	4.21	Overall width	b1/b2 (mm)	800	800	800	800
	4.22	Fork dimensions DIN ISO 2331	s/e/l (mm)	65/185/1150	65/185/1150	65/185/1150	65/185/1150
	4.25	Fork spread	b5 (mm)	570/680	570/680	570/680	570/680
	4.32	Ground clearance, centre of wheelbase	m2 (mm)	25	25	25	25
	4.34.1	Aisle width for pallets 1000 • 1200 crossways	Ast (mm)	2200[2420] ¹⁾	2200[2420] ¹⁾	2200[2420] ¹⁾	2200[2420] ¹⁾
	4.34.2	Aisle width for pallets 800 • 1200 lengthways	Ast (mm)	2250[2390] ²⁾	2250[2390] ²⁾	2250[2390] ²⁾	2250[2390] ²⁾
4.35	Turning radius	Wa (mm)	1550	1550	1550	1550	
Performance data	5.1	Travel speed, laden/unladen	(km/h)	6/6	6/6	6/6	6/6
	5.2	Lift speed, laden/unladen	(m/s)	0.225/0.47	0.195/0.4	0.18/0.4	0.16/0.34
	5.3	Lowering speed, lade/unladen	(m/s)	0.45/0.4	0.45/0.4	0.45/0.4	0.5/0.4
	5.8	Max. gradeability, laden/unladen	(%)	8/16	8/16	6/16	5/16
Electric-engine	6.1	Drive motor rating S2 60 min	(kW)	2.2	2.2	2.2	2.2
	6.2	Lift motor rating at S3 15 %	(kW)	4.2	4.2	4.2	4.2
	6.4	Battery voltage/nominal capacity	(V)/(Ah)	48/80	48/80	48/80	48/80
	6.4.1	Optional battery voltage/nominal capacity	(V)/(Ah)	48/105	48/105	48/105	48/105
	8.1	Type of drive unit		Permanent magnet synchronous			

Note: 1) According to VDI2198 standard+220mm. 2)According to VDI2198 standard+140mm. 3)Triplex full-free+21mm

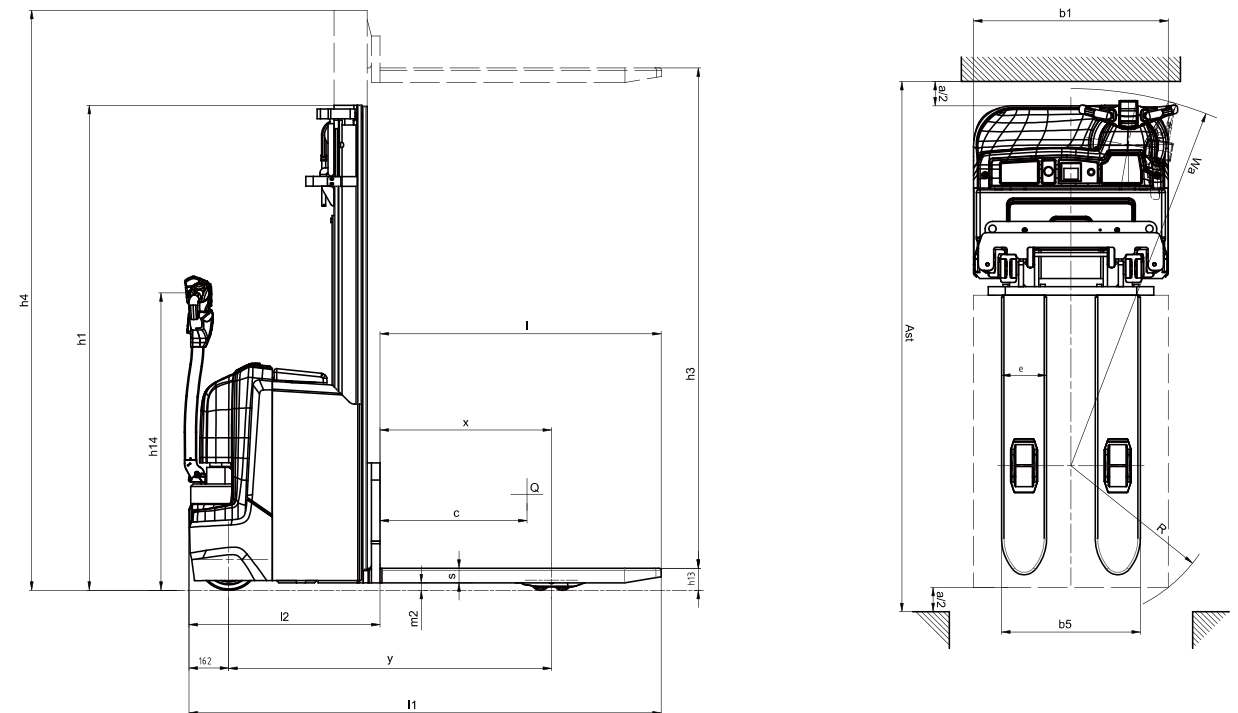
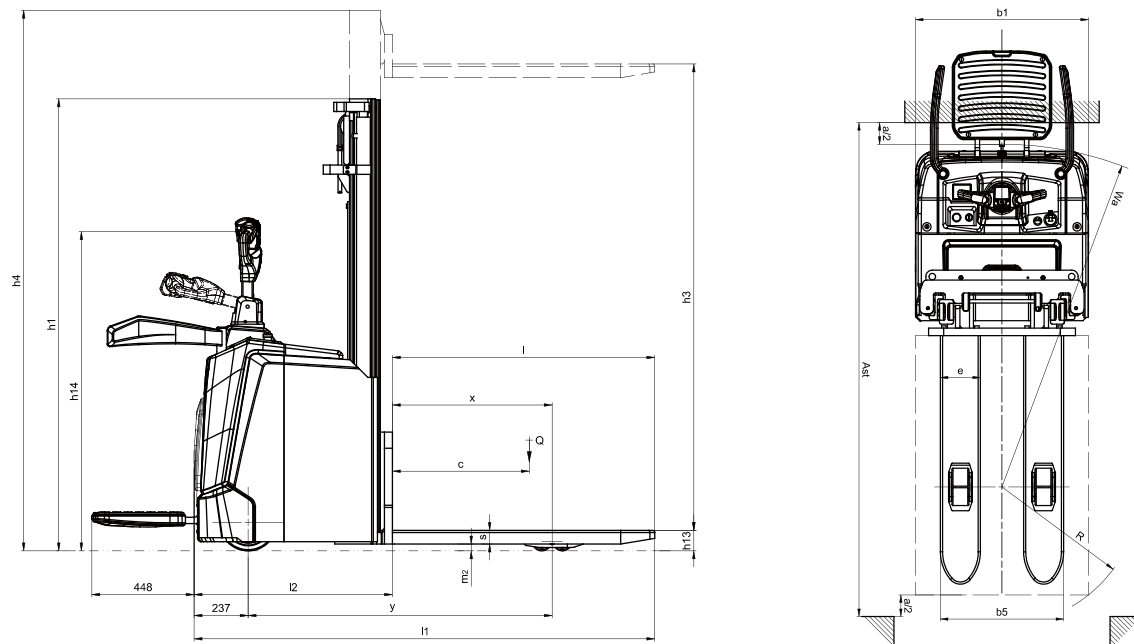



Features

Truck	Standard	Options
48V permanent magnet synchronous drive motor	●	
Hydraulic power unit	●	
PU drive wheel	●	
1150mm fork length	●	
570mm outside fork width	●	
Lifting height limit: 1.8m	●	
Soft landing	●	
48V/80Ah lithium battery(EVE)	●	
Balance wheels	●	
Double load wheels	●	
Fork lift & lower adopts stepless speed regulating	●	
Different length of forks		○
Different width of outside fork		○
Different mast lifting heights		○
48V/105Ah lithium battery (EVE)		○
48V/125Ah lithium battery (CATL)		○
Load backrest		○
Cab		
Interactive meter	●	
Multi-function tiller	●	
Horn	●	
PIN code access	●	
USB	●	
Key switch		○
Controls and instruments		
Electric steering(stand-on type)	●	
Systech controller	●	
Safety		
Emergency disconnect switch	●	
Turning deceleration(stand-on type)	●	
Mast protection		○
Other		
48V30A charger		○
48V50A charger		○

